

# BA-400/400S\* 1/4"-2"

**Bronze Ball Valve  
Two Piece  
Full Port  
600 WOG/150 SWP (1)  
Threaded Ends  
Blow-Out Proof Stem  
MSS SP-110**

## MATERIALS LIST

ITEM	PART	MATERIALS	ASTM SPEC.
1	Body	Cast Bronze	B584
2	Tailpiece	Brass	B283
		Cast Bronze (1 1/4" & up)	B584
3	Ball	Brass w/Hard Chrome Plating	B16
		316 Stainless Steel (BA-400S)	A276
4	Seat	RPTFE, 15% Glass Filled	
5	Stem	Brass	B16
		316 Stainless Steel (BA-400S)	A276
6	Thrust Washer	RPTFE, 25% Glass Filled	
7	Packing	PTFE	
8	Packing Nut	Brass	B16
9	Handle	Steel w/Zinc Plating	Commercial
10	Hand Grip	Vinyl	
11	Handle Nut	Steel w/Zinc Plating	Commercial

(1) For steam service please specify see BA400S3.

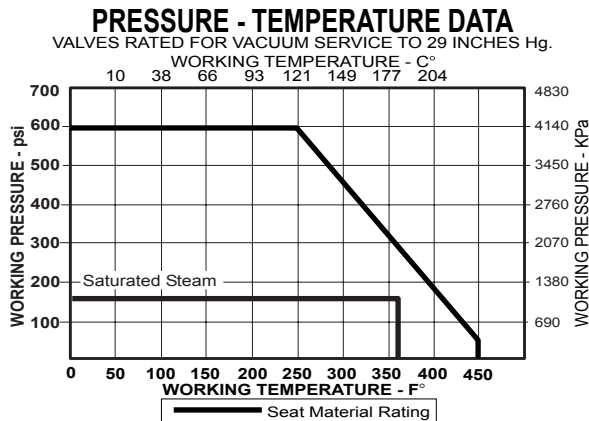

\*Not intended for use in potable water.

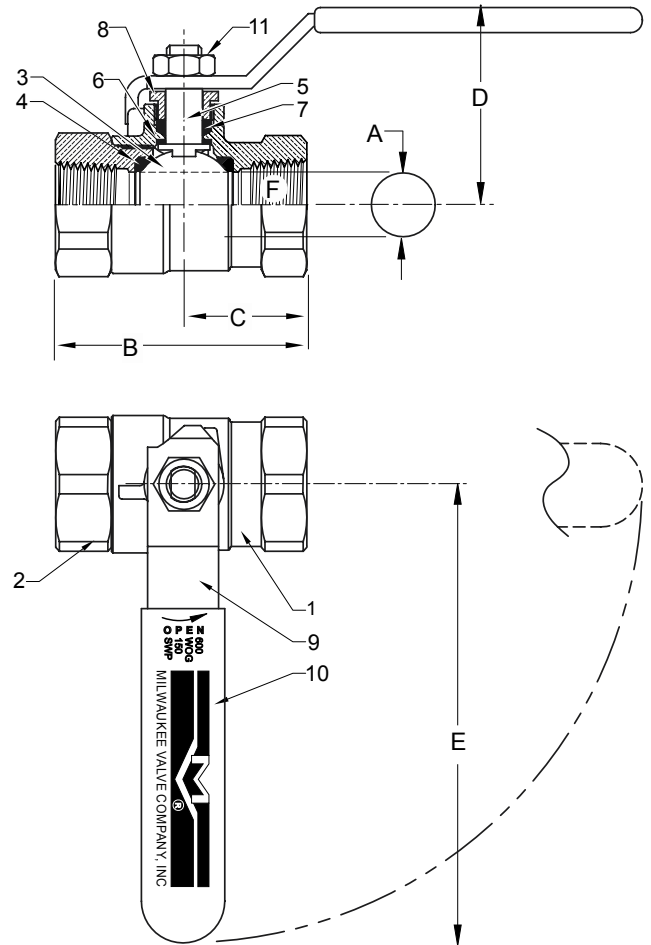

## DIMENSIONS

	UNITS	1/4" DN10	3/8" DN10	1/2" DN15	3/4" DN20	1" DN25	1-1/4" DN32	1-1/2" DN40	2" DN50
A (DIA)	INCHES	0.38	0.38	0.50	0.76	1.06	1.31	1.56	2.00
	mm	10	10	13	19	27	33	40	51
B	INCHES	1.86	1.86	2.19	2.59	3.32	3.77	4.28	5.10
	mm	46	46	54	66	84	96	109	130
C	INCHES	1.00	1.00	1.10	1.30	1.59	1.81	2.06	2.37
	mm	25	25	27	33	40	46	52	60
D	INCHES	1.78	1.81	1.91	2.32	2.68	2.82	3.00	3.36
	mm	44	44	47	59	68	72	76	85
E	INCHES	3.82	3.82	3.82	4.55	6.33	6.33	6.33	7.19
	mm	94	94	94	116	161	161	161	183
F	THREAD SIZE	1/4" NPT	3/8" NPT	1/2" NPT	3/4" NPT	1" NPT	1-1/4" NPT	1-1/2" NPT	2" NPT
Cv		7	7	13	30	61	110	185	360

Note: DN (Diameter Nominal) = Metric equivalent size.

The information presented on this sheet is correct at time of publication. Milwaukee Valve reserves the right to change design and/or materials without notice. For our Installation, Operation and Maintenance Manual and the most current product information go to [www.milwaukeevalve.com](http://www.milwaukeevalve.com).  
⚠ State of California Prop 65 **WARNING:** Cancer and Reproductive Harm. For more information visit [www.p65warnings.ca.gov](http://www.p65warnings.ca.gov).



# OPTIONS

UPBA100/150 / BA100/150  
 UPBA300/350 / BA300/350  
 UPBA400/450 / BA400/450

## TIH THE INSULATOR/MS® Extension Handle

The **THE INSULATOR/MS®** extension handle is designed to prevent condensation and other extraneous moisture from entering the insulated piping system, while also minimizing thermal energy loss from the system via metal extension tubes, levers, and similar parts.



The design incorporates a unique memory stop feature that requires no disassembly or removal of the handle to engage and make adjustments.

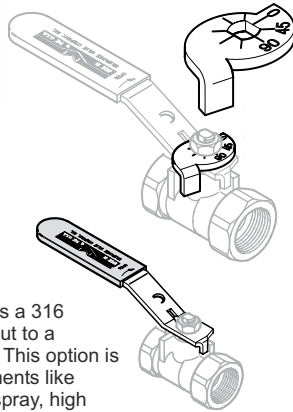

## XLD Locking Extension



The -XLD extended locking handle is made of robust plated steel and provides additional safety benefits for the user. The handle can be locked in both the open and closed positions. Extension length provides for handle clearance above standard piping insulation thicknesses.

## SH Stainless Steel Handle

The "SH" handle option adds a 316 stainless steel handle and nut to a standard bronze ball valve. This option is intended for harsh environments like areas subject to salt water spray, high humidity, harsh cleaning chemicals, etc.

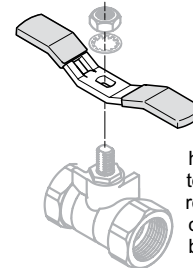
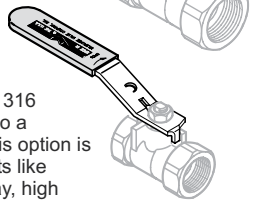

## TH Tee Handle

Tee handles offer the same installation space savings as oval handles, with a slightly shorter end to end dimension. Tee handles require more handle force to operate, so accidental openings can be reduced.

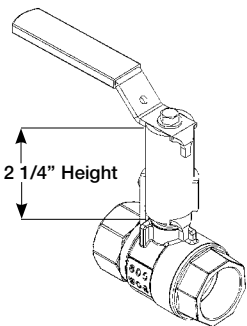

## XM Extension Handle with Memory Stop

The "XM" stem extension is all-metallic with an adjustable memory stop. This option is designed for installations where pipe insulation would make standard handles inoperable. The adjustable memory stop allows the valve opening to be limited to a preset position. This option can be ordered with or without the memory stop.

## OH & LO Milwaukee offers two styles of oval handles, standard oval and a padlocking oval design.

Oval handles can prevent accidental valve operations, since they have less projection than a lever handle, and require more turning force to operate. OSHA requires the use of oval handles in many installations for safety reasons. The locking handle design will accommodate a standard 5/16" pad-lock or other types of valve lockouts.

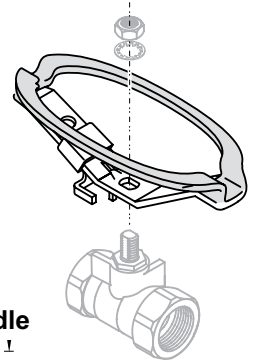

## OH Oval Handle

## XH Extension Stem

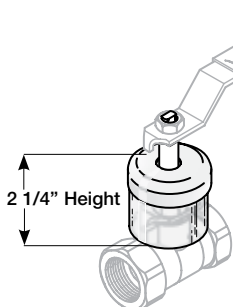

The "XH" stem extension is simple and effective design. This option is designed for installations where pipe insulation would make standard handles inoperable. The external plastic shield helps to keep the insulation away from the stem extension, providing years of trouble free operation.

## LD Locking Device

The "LD" Locking Handle offers the end user the security of a pad lockable handle. The handle can be locked in either the full open position, or full closed by adding a standard padlock. The locking handle design will accommodate a standard 5/16" pad-lock or other types of valve lockouts. The handle and locking device are also manufactured of stainless steel material for additional strength and corrosion resistance.

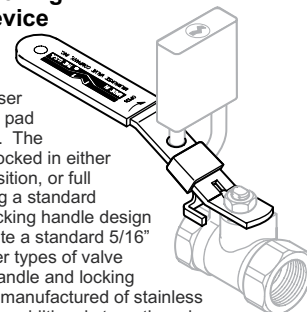

The information presented on this sheet is correct at time of publication. Milwaukee Valve reserves the right to change design and/or materials without notice. For our Installation, Operation and Maintenance Manual and the most current product information go to [www.milwaukeevalve.com](http://www.milwaukeevalve.com).  
 ⚠ State of California Prop 65 **WARNING:** Cancer and Reproductive Harm. For more information visit [www.p65warnings.ca.gov](http://www.p65warnings.ca.gov).

